



# RESOURCES

## MECHANICAL OPTIONS

Please consult factory regarding any questions or inquiries about mechanical options

### SWING-OUT JACKS

- Compatible with selected type of recessed flanged fixtures
- Spring loaded adjustable mounting bracket for mounting in drywall or plaster type ceiling
- Two (2) brackets on each side of fixture housing
- Four (4) per fixture

CAT. NO.	FIXTURE SERIES
<b>SOJ</b> (Set of 4)	FHL310, FHL315, FHL320, FHL330, FHL340, FDH410, FDH420, FDH430, FDH440, FPA510, FPA515, FPA520, FPA530, FPA540, FBL220, FBL229, FHB100, FDC310, FDC320

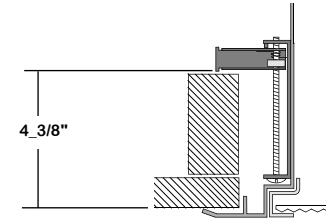

### HANGER YOKES

- Compatible with all types of recessed flanged fixtures
- 1/4 - 20 x 3" machine screws locate into knockouts on back of fixture housing
- Two (2) per fixture

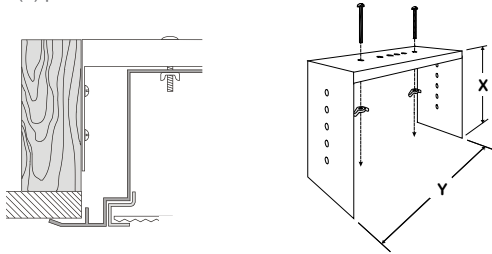

CAT. NO.	FIXTURE SERIES	X	Y
<b>HS-6_1/2</b>	FFF106, FHL306, FWW206	5_1/8"	6_1/2"
<b>HS-10_1/2</b>	FWW200	5_1/8"	10_1/2"
<b>HS-12</b>	FCR210, FCR310, FCR710, FSE110	5_1/8"	12"
<b>HS-12_1/2</b>	FHL310, FDH410, FPA510, FHB100, FIC110, FDC310	5_1/8"	12_1/2"
<b>HS-20</b>	FHL315, FPA515	5_1/8"	20"
<b>HS-24_1/2</b>	FHL320, FDH420, FPA520, RER120, FCR220, FCR720, FSE120, FBL220/229, FIC/FIS120, FDC320	5_1/8"	24_1/2"
<b>HS-36_1/2</b>	FHL330, FDH430, FPA530, RER130	5_1/8"	36_1/2"
<b>HS-48_1/2</b>	FHL340, FDH440, FPA540, RER140	5_1/8"	48_1/2"

### GASKET

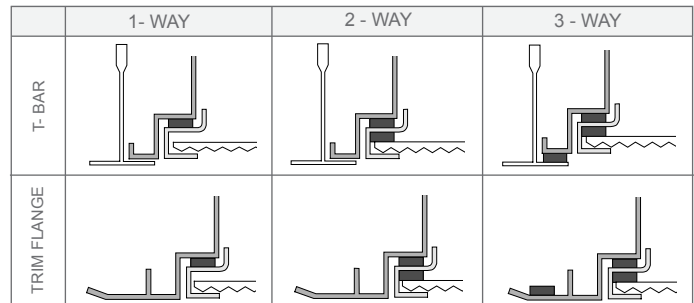
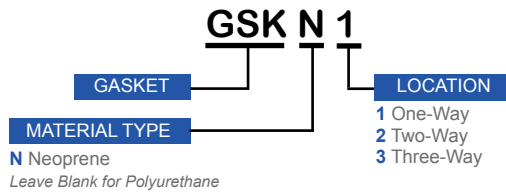

### CHAIN MOUNT COUPLING

- Chain mount coupling with Lift-Up tabs for installation of V-Hooks when chain mounted
- Baked white enamel finish

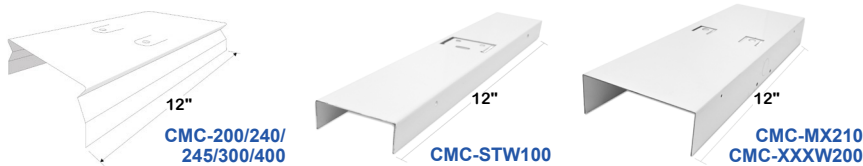

CAT. NO.	FIXTURE SERIES
<b>CMC-200</b>	STR200, STR500, IND200, IND500, IND600
<b>CMC-240</b>	STR240, IND240
<b>CMC-245</b>	KDS200, KDI200, STR220, IND220
<b>CMC-300</b>	STR300, IND300
<b>CMC-400</b>	STR400, IND400
<b>CMC-MX210</b>	MXSTR210, MXIND210
<b>CMC-STW100</b>	STW100 (Only for 4' and 8' fixtures)
<b>CMC-XXW200</b>	STW200, INW200

### CHANNEL HANGERS

- Spaces fixture 1\_1/2" from ceiling while allowing easy installation along gripper groove of housing
- Baked white enamel finish

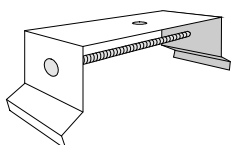

CAT. NO.	FIXTURE SERIES
<b>CH-200</b>	STR200, STR500, IND200, IND500, IND600
<b>CH-240</b>	STR240, IND240, AGS240
<b>CH-300</b>	STR300, IND300
<b>CH-400</b>	STR400, IND400
<b>CH-HB</b>	HBS100, HBW100, HBI600, HBI609
<b>CH-IBT</b>	IBT100, IBT200, IBT300

### CEILING SPACERS

- Minimum one (1) of each per fixture
- May need to drill own holes

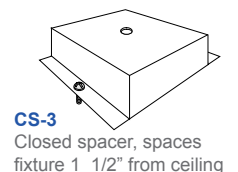
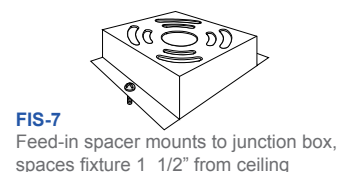

**FIG-7**

Feed-in spacer mounts to junction box, spaces fixture 1\_1/2" from ceiling

**CS-3**

Closed spacer, spaces fixture 1\_1/2" from ceiling



Los Angeles Lighting Mfg. Co.

Headquarters  
10141 Olney Street  
El Monte, CA 91731  
Made in the USA

Contact Us  
T: 626-454-8300  
F: 626-454-8399  
www.lalighting.com

Due to continued product improvements and enhancements, Los Angeles Lighting Manufacturing Company reserves the right to alter specifications, dimensions, data, and/or materials without notice. Please visit our website to view the most current information.

**STEM & CANOPIES SUSPENSION SYSTEM**

- Ball action joint provides a full circumferential 45-degree swivel action
- Canopy bowls turn-lock onto bracket
- Baked white enamel (other finishes available as specified)
- Minimum one (1) of each per fixture

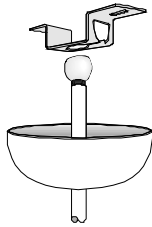

**565**

- No Flash Plate
- Min. Stem Length 12"
- Max. Weight 50 Lbs. Per Stem
- For 3/8" IPS Threaded Stem

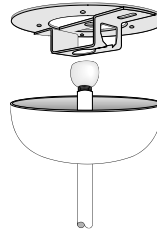

**575S**

- Includes Flash Plate
- Min. Stem Length 6", Max. Weight 20 Lbs. Per Stem
- Min. Stem Length 12", Max. Weight 50 Lbs. Per Stem
- For 3/8" IPS Threaded Stem

**STEMS**

- 3/8" IPS, Nominal OD 5/8"
- Threaded 1" Each End
- Standard Lengths: 6", 12", 18", 24", 30", 36", 48"
- Baked white enamel finish

Note: Other lengths and finishes are available as specified.

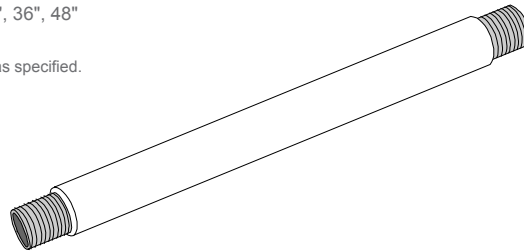

**Stem Length Calculation**

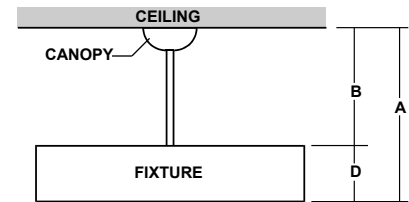

A = Distance from ceiling to bottom of fixture  
 B = Stem length  
 D = Height of fixture  
**Stem Length B=A-D**

**ALUMINUM DIE CAST HUB WITH SAFETY CABLE SET**

**HUB**

- Aluminum die cast hub with set screw for 3/4" pipe
- Safety cable included
- One (1) per fixture

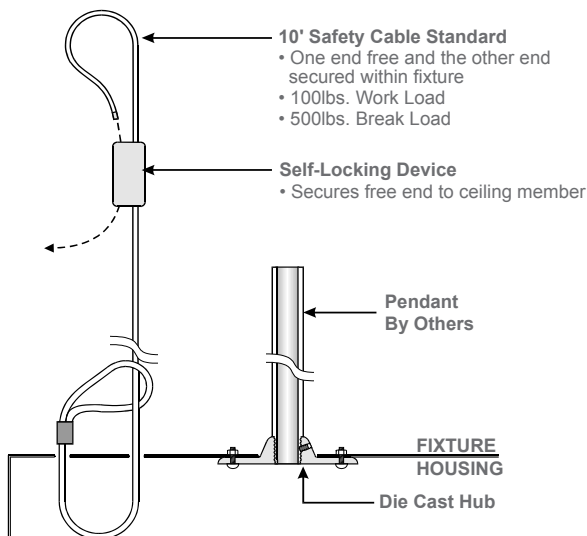
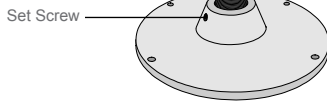

NOTE: Safety cable can be brought through the pipe as specified.

**PENDANT MOUNTING ADAPTER WITH SAFETY CABLE SET**

**SMA**

- 20 ga. die formed galvanized steel mounting adapter for 3/4" pipe
- Die cast aluminum hub for 3/4" pipe pre-installed
- Designed for single point pendant mount applications

Note: Must request pre-punched holes from factory.

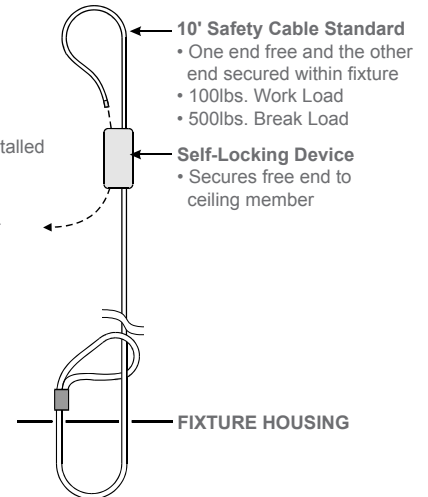
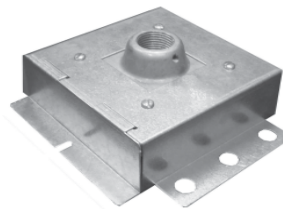

Each Unit Consists of:

- One Mounting Adapter assembly with Lid
- Four 3/8-16 Mounting Bolts
- One Sheet Metal Screw
- One Set Screw
- 10' Safety Cable, one end free and the other end secured within fixture
- Self-Locking Device, secures free end to ceiling member
- Factory Inserted Riv-Nuts

**FIXTURE STABILIZER**

**STA**

- 18 ga. die formed cold rolled steel stabilizer for 3/4" pipe
- Designed for single point pendant mount applications to keep fixture body at a even level
- Works in conjunction with HUB and SMA
- Baked white powder coated finish



**Los Angeles Lighting Mfg. Co.**

Headquarters  
 10141 Olney Street  
 El Monte, CA 91731  
 Made in the USA

Contact Us  
 T: 626-454-8300  
 F: 626-454-8399  
 www.lalighting.com

Due to continued product improvements and enhancements, Los Angeles Lighting Manufacturing Company reserves the right to alter specifications, dimensions, data, and/or materials without notice. Please visit our website to view the most current information.

**Y-TOGGLE-END / CABLE SUSPENSION SYSTEM**

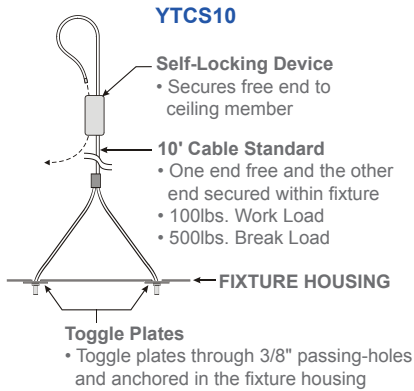

**V-HOOK / CABLE SUSPENSION SYSTEM**

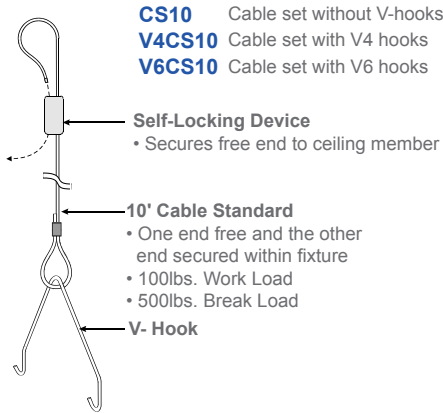

**V-HOOK**

- Hooks install at end of fixture and in "CMC" tabs between fixtures when chain mounted in rows
- Two (2) per fixture

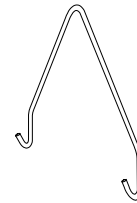

CAT NO.	FOR
<b>V4</b>	4" Leg Height (110/200/240/500 Series)
<b>V6</b>	6" Leg Height (300/400 Series)

**CANOPY / CABLE SUSPENSION SYSTEM**

- Self-locking, one-step adjustable suspension device with canopies
- Provides a full circumferential 360° swivel action

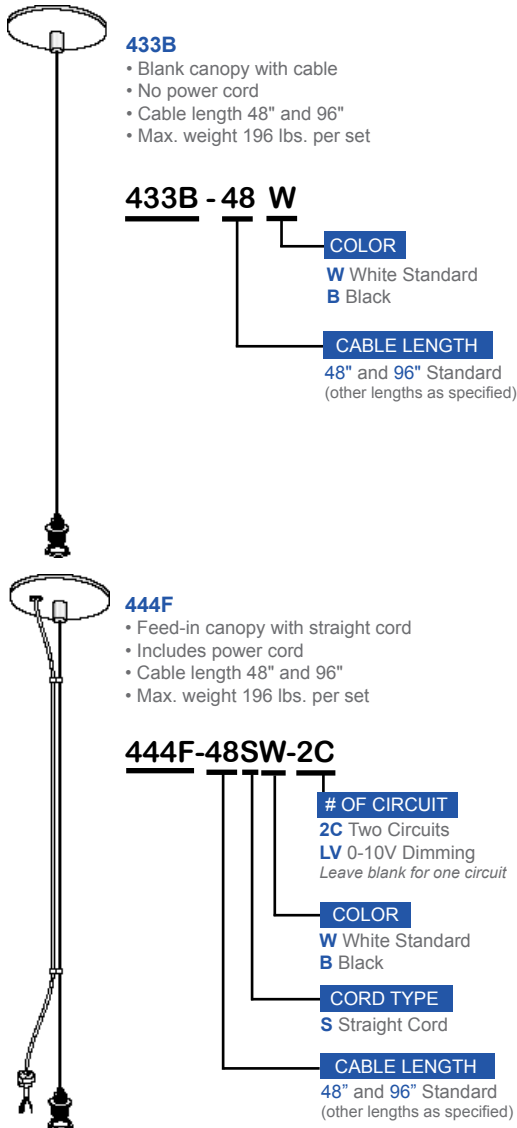

**ROTATABLE HOOK / CABLE MOUNTING SYSTEM**

- Hook / cable mounting system designed for single point hook mounting applications
- Rotatable plate allows fixture to rotate for final adjustment
- Ideal for retrofit project when round shaped HID fixtures are replaced by rectangular shaped fluorescent highbay

**RHC-F36**

- Hook / cable system with fixed length cables

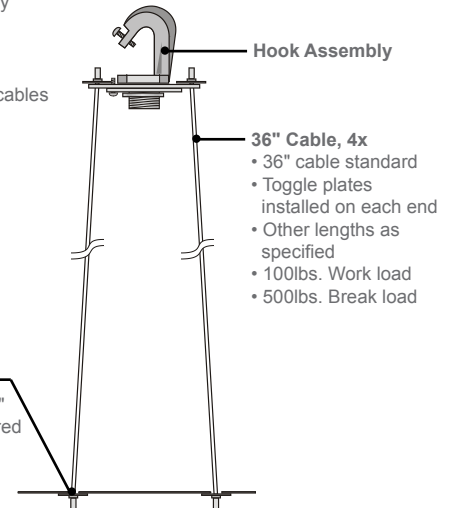
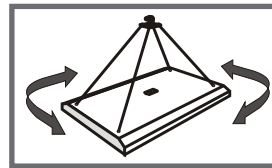

**RHC-A60/F12**

- Hook / cable system with adjustable length cables

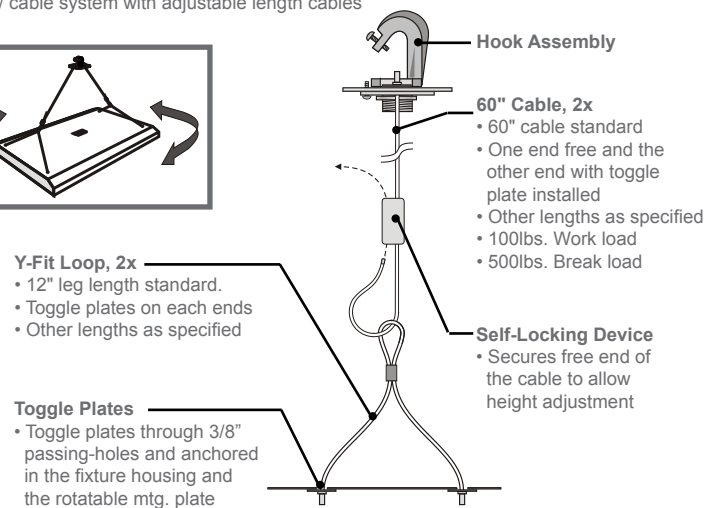
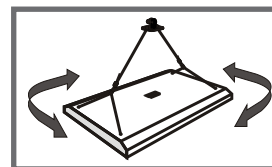

**Los Angeles Lighting Mfg. Co.**

Headquarters  
10141 Olney Street  
El Monte, CA 91731  
Made in the USA

Contact Us  
T: 626-454-8300  
F: 626-454-8399  
www.lalighting.com

Due to continued product improvements and enhancements, Los Angeles Lighting Manufacturing Company reserves the right to alter specifications, dimensions, data, and/or materials without notice. Please visit our website to view the most current information.

## 45-DEGREE MOUNTING BRACKET

**45MB**

- 45-degree mounting bracket designed for mounting lighting fixtures at 45° angle
- Ideal for wall or ceiling mount applications
- 18 ga. electro galvanized steel
- Baked white powder coated finish

Note: Must drill own holes for 45-Degree Mounting Bracket.

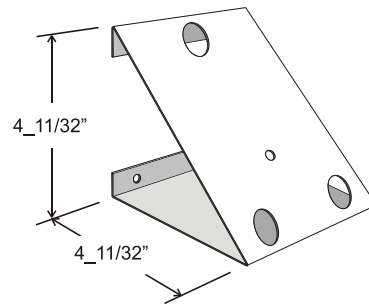
CEILING MOUNTWALL MOUNT**Los Angeles Lighting Mfg. Co.**

Headquarters  
10141 Olney Street  
El Monte, CA 91731  
Made in the USA

Contact Us  
T: 626-454-8300  
F: 626-454-8399  
www.lalighting.com

Due to continued product improvements and enhancements, Los Angeles Lighting Manufacturing Company reserves the right to alter specifications, dimensions, data, and/or materials without notice. Please visit our website to view the most current information.