



RESOURCES

MECHANICAL OPTIONS

Please consult factory regarding any questions or inquiries about mechanical options

SWING-OUT JACKS

- Compatible with selected type of recessed flanged fixtures
- Spring loaded adjustable mounting bracket for mounting in drywall or plaster type ceiling
- Two (2) brackets on each side of fixture housing
- Four (4) per fixture

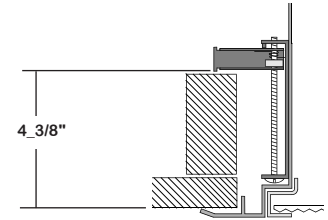

CAT. NO.	FIXTURE SERIES
SOJ (Set of 4)	FHL310, FHL315, FHL320, FHL330, FHL340, FDH410, FDH420, FDH430, FDH440, FPA510, FPA515, FPA520, FPA530, FPA540, FBL220, FBL229, FHB100, FDC310, FDC320

HANGER YOKES

- Compatible with all types of recessed flanged fixtures
- 1/4 - 20 x 3" machine screws locate into knockouts on back of fixture housing
- Two (2) per fixture

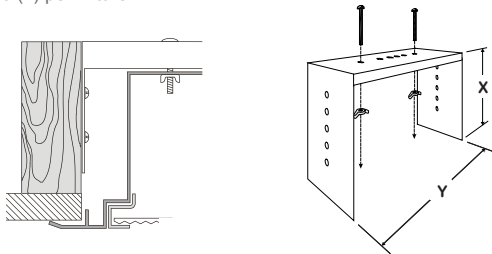

CAT. NO.	FIXTURE SERIES	X	Y
HS-6_1/2	FFF106, FHL306, FWW206	5_1/8"	6_1/2"
HS-10_1/2	FWW200	5_1/8"	10_1/2"
HS-12	FCR210, FCR310, FCR710, FSE110	5_1/8"	12"
HS-12_1/2	FHL310, FDH410, FPA510, FHB100, FIC110, FDC310	5_1/8"	12_1/2"
HS-20	FHL315, FPA515	5_1/8"	20"
HS-24_1/2	FHL320, FDH420, FPA520, RER120, FCR220, FCR720, FSE120, FBL220/229, FIC/FIS120, FDC320	5_1/8"	24_1/2"
HS-36_1/2	FHL330, FDH430, FPA530, RER130	5_1/8"	36_1/2"
HS-48_1/2	FHL340, FDH440, FPA540, RER140	5_1/8"	48_1/2"

GASKET

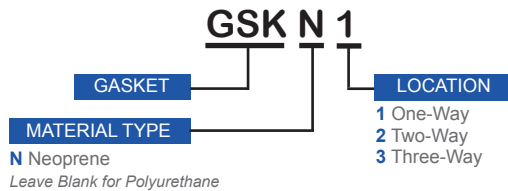

	1 - WAY	2 - WAY	3 - WAY
T-BAR			
TRIM FLANGE			

CHAIN MOUNT COUPLING

- Chain mount coupling with Lift-Up tabs for installation of V-Hooks when chain mounted
- Baked white enamel finish



CAT. NO.	FIXTURE SERIES
CMC-200	STR200, STR500, IND200, IND500, IND600
CMC-240	STR240, IND240
CMC-245	KDS200, KDI200, STR220, IND220
CMC-300	STR300, IND300
CMC-400	STR400, IND400
CMC-MX210	MXSTR210, MXIND210
CMC-INW1XX	INW105, INW111
CMC-STW100	STW100 (Only for 4' and 8' fixtures)
CMC-XXW200	STW200, INW200

CHANNEL HANGERS

- Spaces fixture 1_1/2" from ceiling while allowing easy installation along gripper groove of housing
- Baked white enamel finish

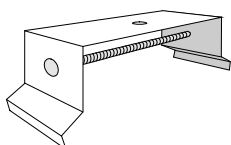

CAT. NO.	FIXTURE SERIES
CH-200	STR200, STR500, IND200, IND500, IND600
CH-240	STR240, IND240, AGS240
CH-300	STR300, IND300
CH-400	STR400, IND400
CH-HB	HBS100, HBW100, HBI600, HBI609
CH-IBT	IBT100, IBT200, IBT300

CEILING SPACERS

- Minimum one (1) of each per fixture
- May need to drill own holes

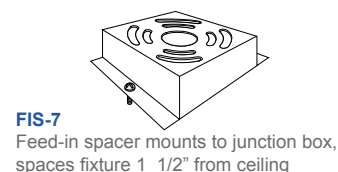
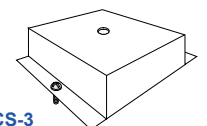

FIG-7

Feed-in spacer mounts to junction box, spaces fixture 1_1/2" from ceiling



CS-3

Closed spacer, spaces fixture 1_1/2" from ceiling



Los Angeles Lighting Mfg. Co.

Headquarters
10141 Olney Street
El Monte, CA 91731
Made in the USA

Contact Us
T: 626-454-8300
F: 626-454-8399
www.lalighting.com

Due to continued product improvements and enhancements, Los Angeles Lighting Manufacturing Company reserves the right to alter specifications, dimensions, data, and/or materials without notice. Please visit our website to view the most current information.

STEM & CANOPIES SUSPENSION SYSTEM

- Ball action joint provides a full circumferential 45-degree swivel action
- Canopy bowls turn-lock onto bracket
- Baked white enamel (other finishes available as specified)
- Minimum one (1) of each per fixture

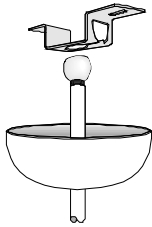

565

- No Flash Plate
- Min. Stem Length 12"
- Max. Weight 50 Lbs. Per Stem
- For 3/8" IPS Threaded Stem

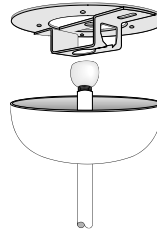

575S

- Includes Flash Plate
- Min. Stem Length 6", Max. Weight 20 Lbs. Per Stem
- Min. Stem Length 12", Max. Weight 50 Lbs. Per Stem
- For 3/8" IPS Threaded Stem

STEMS

- 3/8" IPS, Nominal OD 5/8"
- Threaded 1" Each End
- 2 lock nuts provided per stem
- Standard Lengths: 6", 12", 18", 24", 30", 36", 48"
- Baked white enamel finish

Note: Other lengths and finishes are available as specified.

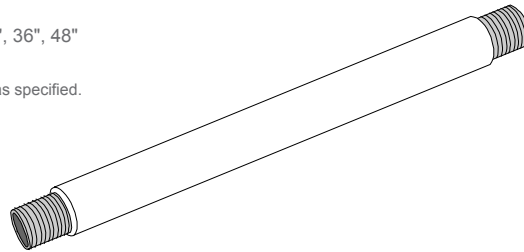

Stem Length Calculation

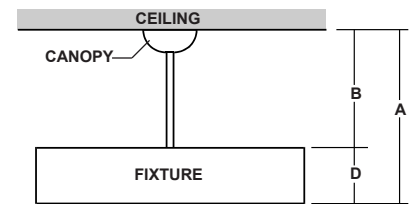

A = Distance from ceiling to bottom of fixture
 B = Stem length
 D = Height of fixture
 Stem Length B=A-D

ALUMINUM DIE CAST HUB WITH SAFETY CABLE SET

HUB

- Aluminum die cast hub with set screw for 3/4" pipe
- Safety cable included
- One (1) per fixture

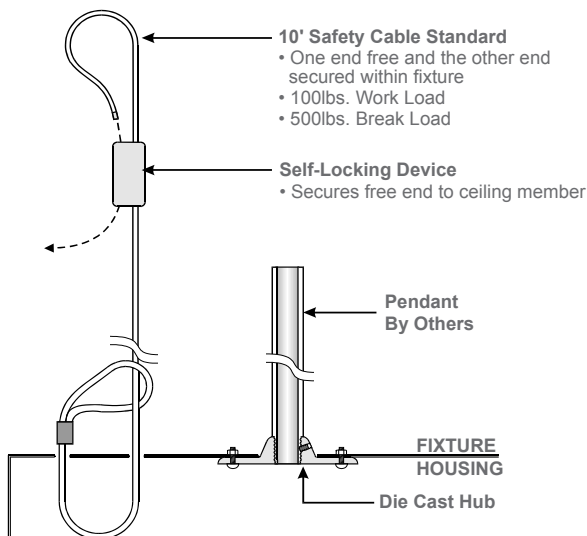
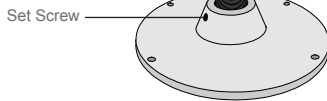

NOTE: Safety cable can be brought through the pipe as specified.

PENDANT MOUNTING ADAPTER WITH SAFETY CABLE SET

SMA

- 20 ga. die formed galvanized steel mounting adapter for 3/4" pipe
- Die cast aluminum hub for 3/4" pipe pre-installed
- Designed for single point pendant mount applications

Note: Must request pre-punched holes from factory.

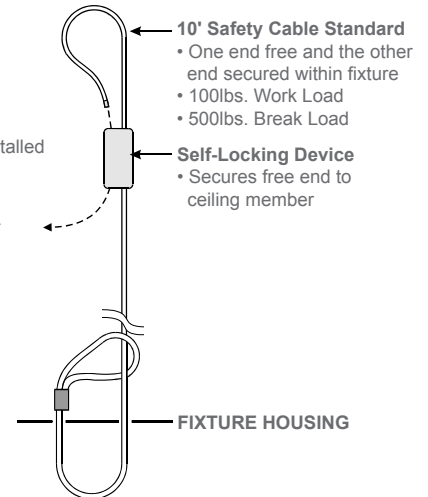
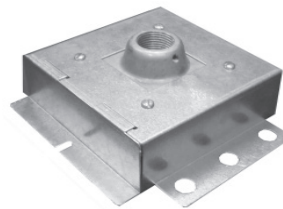

Each Unit Consists of:

- One Mounting Adapter assembly with Lid
- Four 3/8-16 Mounting Bolts
- One Sheet Metal Screw
- One Set Screw
- 10' Safety Cable, one end free and the other end secured within fixture
- Self-Locking Device, secures free end to ceiling member
- Factory Inserted Riv-Nuts

FIXTURE STABILIZER

STA

- 18 ga. die formed cold rolled steel stabilizer for 3/4" pipe
- Designed for single point pendant mount applications to keep fixture body at a even level
- Works in conjunction with HUB and SMA
- Baked white powder coated finish



Los Angeles Lighting Mfg. Co.

Headquarters
 10141 Olney Street
 El Monte, CA 91731
 Made in the USA

Contact Us
 T: 626-454-8300
 F: 626-454-8399
 www.lalighting.com

Due to continued product improvements and enhancements, Los Angeles Lighting Manufacturing Company reserves the right to alter specifications, dimensions, data, and/or materials without notice. Please visit our website to view the most current information.

Y-TOGGLE-END / CABLE SUSPENSION SYSTEM

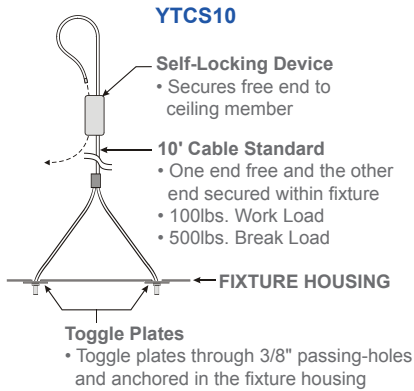

V-HOOK / CABLE SUSPENSION SYSTEM

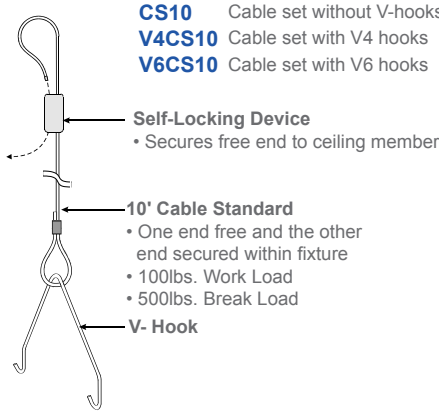

V-HOOK

- Hooks install at end of fixture and in "CMC" tabs between fixtures when chain mounted in rows
- Two (2) per fixture

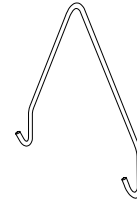

CAT NO.	FOR
V4	4" Leg Height (110/200/240/500 Series)
V6	6" Leg Height (300/400 Series)

CANOPY / CABLE SUSPENSION SYSTEM

- Self-locking, one-step adjustable suspension device with canopies
- Provides a full circumferential 360° swivel action

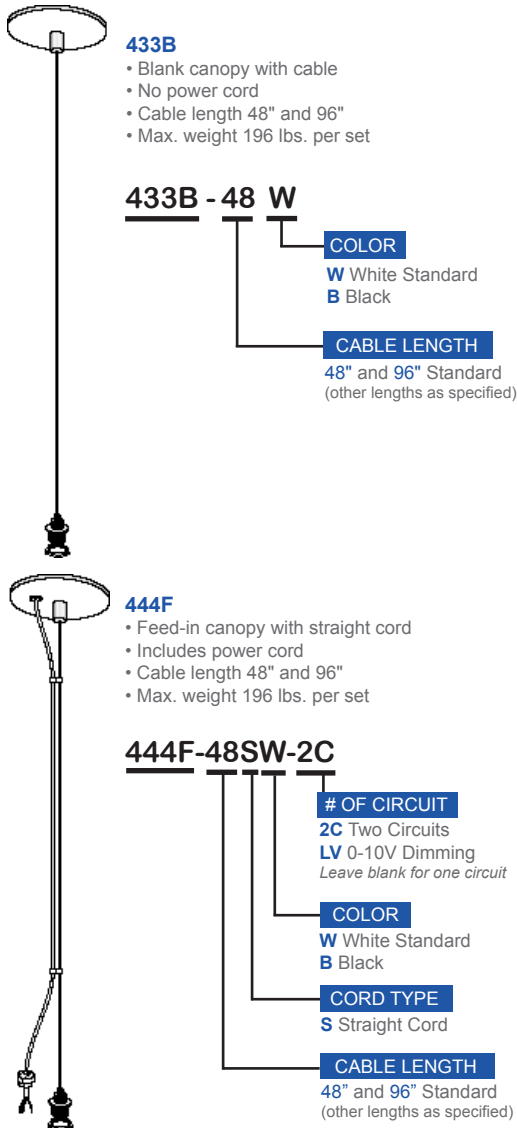

ROTATABLE HOOK / CABLE MOUNTING SYSTEM

- Hook / cable mounting system designed for single point hook mounting applications
- Rotatable plate allows fixture to rotate for final adjustment
- Ideal for retrofit project when round shaped HID fixtures are replaced by rectangular shaped fluorescent highbay

RHC-F36

- Hook / cable system with fixed length cables

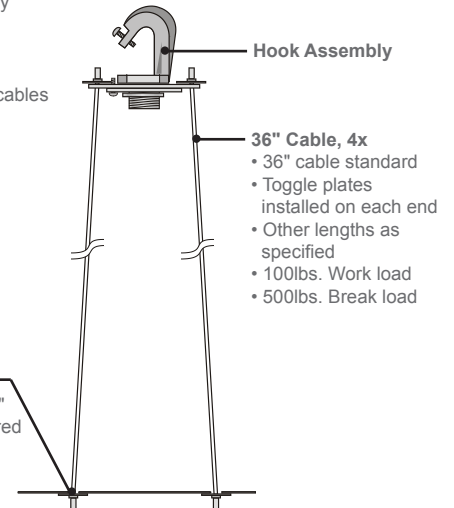
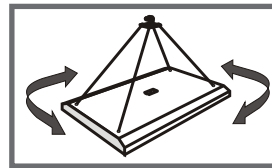

RHC-A60/F12

- Hook / cable system with adjustable length cables

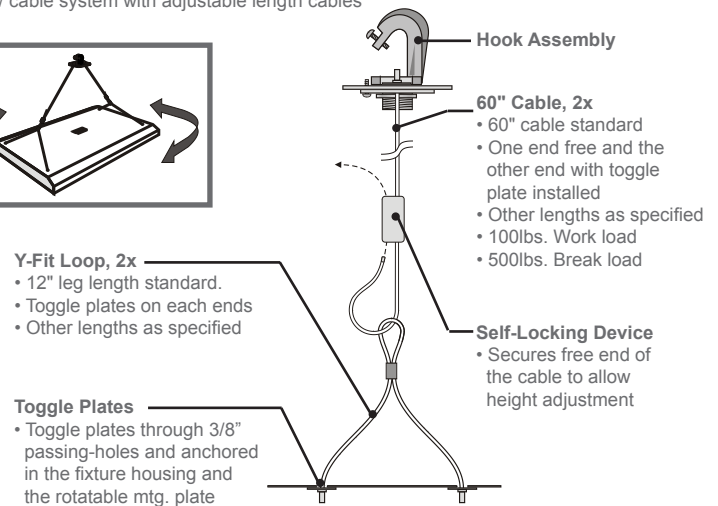
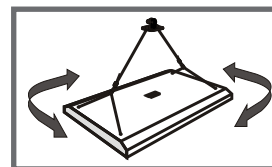

Los Angeles Lighting Mfg. Co.

Headquarters
10141 Olney Street
El Monte, CA 91731
Made in the USA

Contact Us
T: 626-454-8300
F: 626-454-8399
www.lalighting.com

Due to continued product improvements and enhancements, Los Angeles Lighting Manufacturing Company reserves the right to alter specifications, dimensions, data, and/or materials without notice. Please visit our website to view the most current information.

45-DEGREE MOUNTING BRACKET

45MB

- 45-degree mounting bracket designed for mounting lighting fixtures at 45° angle
- Ideal for wall or ceiling mount applications
- 18 ga. electro galvanized steel
- Baked white powder coated finish

Note: Must drill own holes for 45-Degree Mounting Bracket.

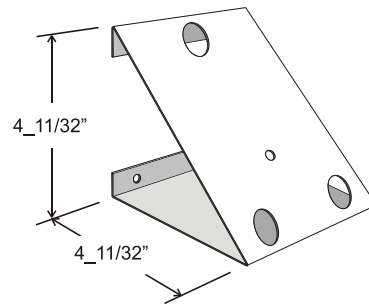
CEILING MOUNTWALL MOUNT**Los Angeles Lighting Mfg. Co.**

Headquarters
10141 Olney Street
El Monte, CA 91731
Made in the USA

Contact Us
T: 626-454-8300
F: 626-454-8399
www.lalighting.com

Due to continued product improvements and enhancements, Los Angeles Lighting Manufacturing Company reserves the right to alter specifications, dimensions, data, and/or materials without notice. Please visit our website to view the most current information.