



BAYLIGHTER™ LED

EBY450 (4FT) SERIES

ENCLOSED HIGH BAY LUMINAIRE

DATE	
JOB	

WWW.LALIGHTING.COM
626-454-8300

SURFACE/PENDANT/SUSPENSION MOUNTED HIGH BAY LED LUMINAIRE



DIMENSIONS

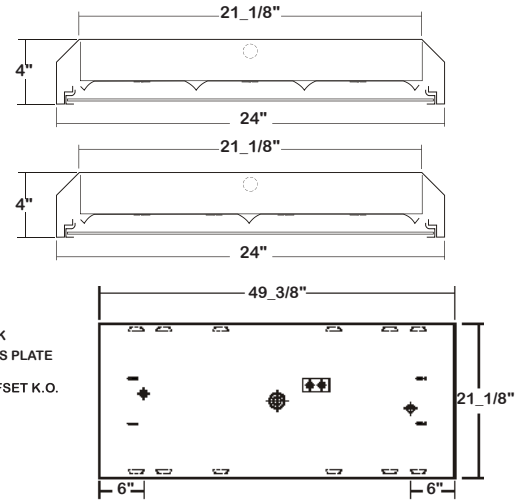

APPLICATIONS

- Commercial, Industrial, Warehouse

FEATURES

- 0-10V dimming driver standard
- Supports California Title 24 compliance
- Safety cables attached to door frame and LED gear tray

OPTIONS

- **High (HT)** ambient temperature version available for extreme temperature ranges
- Full customization available upon request
- Additional lumen packages and color temperatures available
- Controls and sensors available
- Wireless control options available
- Custom colors available
- Variety of lenses available
- Available without door and lens assembly
- Emergency battery pack available
- 11 ga. wire guard available
- Cable suspension systems available
- Ceiling spacers available

SPECIFICATIONS

CONSTRUCTION

- 22 ga. cold rolled steel housing with louvered vents for heat removal (20 ga. C.R.S. and 0.040 aluminum housing available as specified)
- 20 ga. cold rolled steel door frame secured by T-hinges and positive spring loaded latches
- One way polyurethane gasket standard

FINISH

- Baked white polyester finish (powder coated finish available) / minimum reflectance 86%

OPTICAL

- Clear prismatic acrylic lens standard

ELECTRICAL

- High efficiency drivers coupled with long-life LEDs
- Service life tested at 50,000 hours (L70)
- Universal voltage 120V through 277V (347V / 480V available)
- Power Factor (PF) ≥ 0.9
- Total Harmonic Distortion (THD) ≤ 20%

LISTING

- UL USA and Canada listed / suitable for damp locations

WARRANTY

- 5-year limited warranty



Los Angeles Lighting Mfg. Co.
 Contact Us
 T: 626-454-8300 10141 Olney Street
 F: 626-454-8399 El Monte, CA 91731
 www.lalighting.com Made in the USA



Due to continued product improvements and enhancements, Los Angeles Lighting Manufacturing Company reserves the right to alter specifications, dimensions, data, and/or materials without notice. Please visit our website to view the most current information.

© 2022 LOS ANGELES LIGHTING MANUFACTURING CO. ALL RIGHTS RESERVED.

Revision: 06/19/23



ORDERING INFORMATION EXAMPLE: EBY450-42-4L-XX-DRDM-UNV-3/840HT

SERIES	LED LUMEN PACKAGE	NOMINAL LENGTH	OPTICAL / DOOR FRAME	MECHANICAL	ELECTRICAL	DRIVER	VOLTAGE	# OF LED ROW	CRI / CCT	AMBIENT TEMP.
EBY450		4L				DRDM	UNV	3		HT
EBY450 Enclosed High Bay LED Luminaire (HT - High Ambient Temperature Version)	42 Nom. 42000 Lumens *Additional Lumen Packages Available	4L 4'	PA Clear Prismatic Acrylic PA2 Clear Prismatic Acrylic Nom. 0.125 FPA2 Frosted Prismatic Acrylic Nom. 0.125 XX No Door & Lens Assembly	GSKNx Neoprene Gasket HUB Aluminum Die Cast Hub (Safety Cable Set Included) SMA Pendant Mounting Adapter (Safety Cable Set Included) STA Fixture Stabilizer *Leave Blank if Not Specified Additional Mechanical Options	BPL1.5 1500 lm Emergency Battery Pack MSxx Motion Sensor *Leave Blank if Not Specified Additional Electrical Options	DRDM 0-10V Dimming Driver	UNV 120V-277V	3 Three LED Rows	835 80+CRI / 3500K Color Temp. 840 80+CRI / 4000K Color Temp. 850 80+CRI / 5000K Color Temp. *Additional Color Temp. Available	HT High Ambient Temp.
Standard options for EBY450 shown above. For additional options, including lumen packages, controls, lenses, switches, finishes, and more, visit www.lalighting.com/resources or contact customer service.										

SYSTEM DATA

THESE ARE THE MOST POPULAR LUMEN PACKAGES. PLEASE CONSULT FACTORY FOR ADDITIONAL SYSTEM DATA.

LED LUMEN PACKAGE	NORMAL AMBIENT TEMPERATURE (HIGH EFFICACY) PRODUCT CODE	DELIVERED LUMENS	SYSTEM WATTS	LUMINAIRE EFFICACY	AMBIENT TEMP.	FLUORESCENT EQUIVALENT	IES FILES
42000 Lumens (Nominal)	MHL340-42-4L-PA-DRDM-UNV-3/840HT	36329 lm	261.0 W	139.2 lm/W	-20°C / 35°C	10-F54T5HO	*

NOTE:
System data is based on 120V input voltage. Actual performance may differ as a result of end-user environment and application.

This fixture has been tested and listed in accordance with UL Standards. L.A. Lighting certifies that it will operate safely when installed properly, and within an ambient temperature range noted in the system data table.

Additional lumen packages and color temperatures available.



Los Angeles Lighting Mfg. Co.
 Contact Us
 T: 626-454-8300 10141 Olney Street
 F: 626-454-8399 El Monte, CA 91731
www.lalighting.com Made in the USA



Due to continued product improvements and enhancements, Los Angeles Lighting Manufacturing Company reserves the right to alter specifications, dimensions, data, and/or materials without notice. Please visit our website to view the most current information.

© 2022 LOS ANGELES LIGHTING MANUFACTURING CO. ALL RIGHTS RESERVED.

Revision: 06/19/23



MADE IN THE USA
BAA Compliant

GASKET

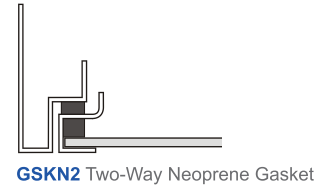
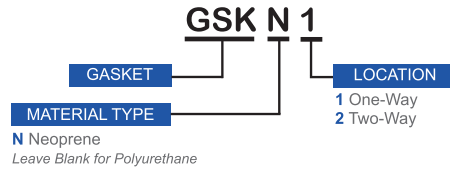

OPTICAL OPTIONS

STANDARD LENSES

PA	Clear Prismatic Acrylic, No Thickness Specified, Female Prisms 3/16 Square Base
FPA2	Frosted Prismatic Acrylic, Nom. 0.125 OA Thickness
PA2	Clear Prismatic Acrylic, Nom. 0.125 OA Thickness, Female Prisms 3/16 Square Base
CA	Clear Acrylic, No Thickness Specified
DRP2	High Impact Clear Prismatic Acrylic, Nom. 0.125 OA Thickness, Female Prisms 3/16 Square Base
DRP8	High Impact Clear Prismatic Acrylic, Nom. 0.187 OA Thickness, Female Prisms 3/16 Square Base

ADDITIONAL AVAILABLE LENSES

(Not all optics suitable for fixture. Please consult factory to ensure selected optical option suits fixture. Please consult factory regarding any optical options not shown)

EXTRUDED PRISMATIC PATTERNS

PA3	Clear Prismatic Acrylic, Min. 0.125 OA Thickness, Female Prisms 3/16 Square Base
PA8	Clear Prismatic Acrylic, Nom. 0.187 OA Thickness, Female Prisms 3/16 Square Base
P15	Clear Prismatic Acrylic, Nom. 0.200 OA Thickness, Female Prisms 3/8 Square Base
P195	Clear Prismatic Acrylic, Nom. 0.150 OA Thickness, Male Conical Prisms 3/16 Square Base
P198	Clear Prismatic Acrylic, Nom. 0.187 OA Thickness, Male Conical Prisms 3/16 Square Base
PWA2	White Prismatic Acrylic, Nom. 0.125 OA Thickness, Female Prisms 3/16 Square Base
P3E	3E Batwing Pattern Lens
P195RF	Clear Prismatic Acrylic, 19 Shunts Radio Frequencies To Ground, Nom. 0.150 OA Thickness
PA2UV	Clear Prismatic Acrylic, UV Blocking, Nom. 0.125 OA Thickness

FLAT DIFFUSERS

FWA	Flat White Acrylic, No Thickness Specified, Stippled Finish	FWA2	Flat White Acrylic, Nom. 0.125 Thickness, Stippled Finish
FFA	Frosted Flat Acrylic, No Thickness Specified	FFA2	Frosted Flat Acrylic, Nom. 0.125 Thickness
CA8	Clear Acrylic, Nom. 0.187 OA Thickness	CA2	Clear Acrylic, Nom. 0.125 OA Thickness

HIGH IMPACT

VL25	Clear Polycarbonate, Nom. 0.125 Thickness with 0.125 Clear Prismatic Acrylic Overlay
VL37	Clear Polycarbonate, Nom. 0.250 Thickness with 0.125 Clear Prismatic Acrylic Overlay
CPC2	Clear Polycarbonate, Nom. 0.125 OA Thickness
CPC8	Clear Polycarbonate, Nom. 0.187 OA Thickness
PPC2	Clear Prismatic Polycarbonate, Nom. 0.125 OA Thickness, Female Prisms 3/16 Square Base
PPC8	Clear Prismatic Polycarbonate, Nom. 0.187 OA Thickness, Female Prisms 3/16 Square Base
DRP3	High Impact Clear Prismatic Acrylic, Min. 0.125 OA Thickness, Female Prisms 3/16 Square Base



Los Angeles Lighting Mfg. Co.
 Contact Us
 T: 626-454-8300 10141 Olney Street
 F: 626-454-8399 El Monte, CA 91731
 www.lalighting.com Made in the USA



Due to continued product improvements and enhancements, Los Angeles Lighting Manufacturing Company reserves the right to alter specifications, dimensions, data, and/or materials without notice. Please visit our website to view the most current information.

© 2022 LOS ANGELES LIGHTING MANUFACTURING CO. ALL RIGHTS RESERVED.

Revision: 06/19/23



ACCESSORIES

V6

- 6" Leg Height V-Hook
- Two (2) per fixture

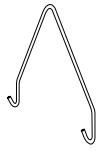

WG11-EBY450

- 11 ga. Wire Guard
- Chrome epoxy powder coated finish

Cable Suspension System

- See Mechanical Options for additional Cable Suspension Systems

Ceiling Spacers

- Minimum one (1) of each per fixture
- Must drill own holes

Note: Ceiling spacers only required when 32000 / 36000 lumens system is specified.

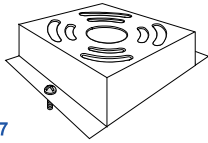

FIS-7

Feed-in spacer mounts to junction box, spaces fixture 1_1/2" from ceiling

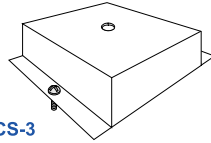

CS-3

Closed spacer, spaces fixture 1_1/2" from ceiling

YTCS10

- Y-Toggle-End / Cable Suspension System

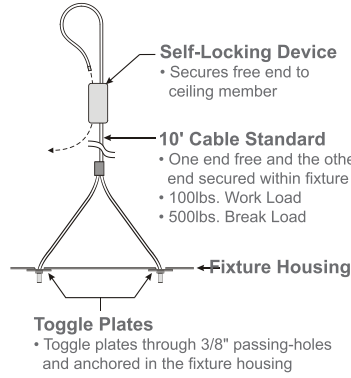

V6CS10

- V-Hook / Cable Suspension System
- Cable set with V6 hooks

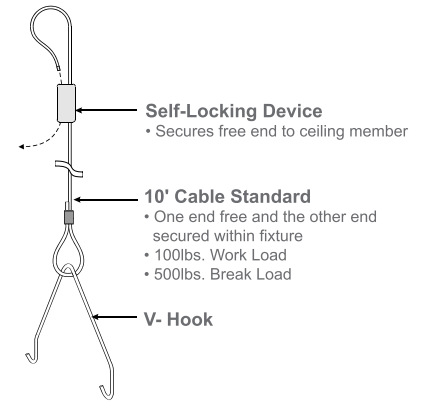

CUSTOM COLORS

BLK - Matte Black

CS - Camaro Silver

BZ - Statuary Bronze

Variety of RAL colors & Axalta/DuPont colors available upon request.



Los Angeles Lighting Mfg. Co.

Contact Us
T: 626-454-8300 10141 Olney Street
F: 626-454-8399 El Monte, CA 91731
www.lalighting.com Made in the USA



Due to continued product improvements and enhancements, Los Angeles Lighting Manufacturing Company reserves the right to alter specifications, dimensions, data, and/or materials without notice. Please visit our website to view the most current information.

© 2022 LOS ANGELES LIGHTING MANUFACTURING CO. ALL RIGHTS RESERVED.

Revision: 06/19/23



MADE IN THE USA
BAA Compliant