



# RESOURCES MOUNTING HARDWARE

Revised: 02/14/23

Contact customer service for more information about mounting options.

Ⓜ Not all mounting hardware options are suitable for all fixtures.

## SWING-OUT JACKS

- Spring-loaded adjustable mounting bracket for mounting in drywall or plaster type ceiling
- Compatible with recessed flanged fixtures shown below
- Four (4) per set; 1 set required per fixture

CAT. NO	LUMINAIRE MODEL
SOJ	FBL220, FBL229, FDH430, FDH440, FHB100, FHL310, FHL315, FHL320, FHL330, FHL340, FPA310, FPA320, FPA330, FPA340, FPA610, FPA620, FPA630, FPA640
SOJ-FDC-2	FDC320 (2FT MODEL)
SOJ-FDC-4	FDC320 (4FT MODEL)

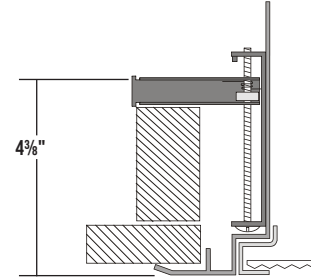

## HANGER YOKES

- Compatible with all types of recessed flanged fixtures
- 1/4"-20 x 2 1/2" machine screws secure hanger yoke to fixture through knockouts in top of housing
- Two hanger yokes required for each 2', 3', or 4' fixture. Four hanger yokes required for each 6' or 8' fixture.

CAT. NO	LUMINAIRE MODEL	H	W
HS-6 1/2	FFF106, FHL306, FWW206	5 1/8"	6 1/2"
HS-10 1/2	FWW210		10 1/2"
HS-12	FCR210, FCR310, FCR710, FIC110, FSE110		12"
HS-12 1/2	FDC310, FDH410, FHB100, FHL310, FIC100, FPA310, FPA610		12 1/2"
HS-20	FHL315		20"
HS-24 1/2	FBL220, FBL229, FCR220, FCR720, FCR721, FDC320, FDH420, FHL320, FIC120, FIS120, FPA320, FPA620, FSE120, RER120		24 1/2"
HS-36 1/2	FDH430, FHL330, FPA330, FPA630, RER130		36 1/2"
HS-48 1/2	FDH440, FHL340, FPA340, FPA640, RER140		48 1/2"

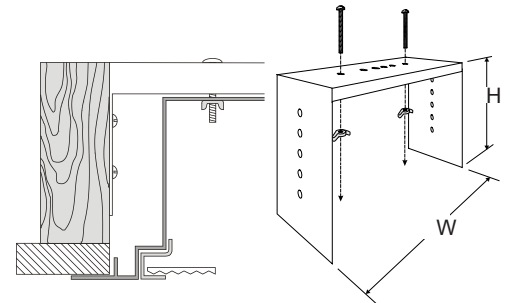

## CANOPY / CABLE SUSPENSION SYSTEM

- Self-locking, one-step adjustable suspension device with canopies
- Provides full 360° rotation

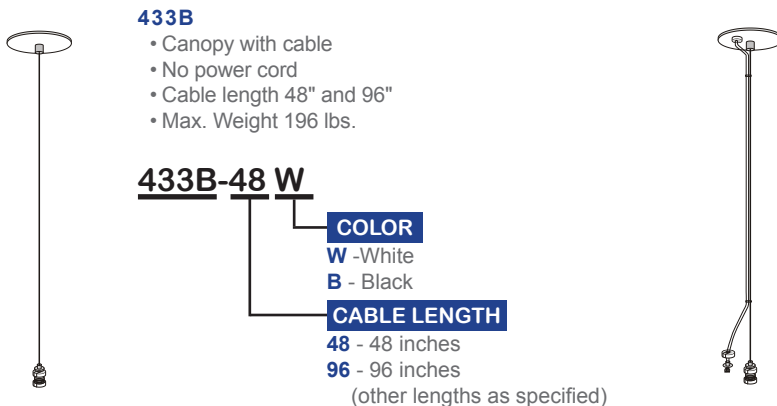

### 433B

- Canopy with cable
- No power cord
- Cable length 48" and 96"
- Max. Weight 196 lbs.

### 433B-48 W

#### COLOR

- W - White
- B - Black

#### CABLE LENGTH

- 48 - 48 inches
- 96 - 96 inches

(other lengths as specified)

### 444F

- Feed-in canopy with straight cord
- Includes power cord
- Cable length 48" and 96"
- Max. Weight 196 lbs

### 444F-48SW-2C

#### # OF CIRCUITS

- 2C - Two circuits
- LV - 0-10V dimming
- Blank - One circuit

#### COLOR

- W - White
- B - Black

#### CORD TYPE

- S - Straight cord

#### CABLE LENGTH

- 48 - 48 inches
- 96 - 96 inches

(other lengths as specified)



Los Angeles Lighting Mfg. Co.

Contact Us

T: 626-454-8300

F: 626-454-8399

www.lalighting.com

10141 Olney Street

El Monte, CA 91731

Made in the USA



Due to continued product improvements and enhancements, Los Angeles Lighting Manufacturing Company reserves the right to alter specifications, dimensions, data, and/or materials without notice.

Please visit our website to view the most current information.

© 2023 LOS ANGELES LIGHTING MANUFACTURING CO. ALL RIGHTS RESERVED.



MADE IN THE USA  
BAA Compliant

**CANOPY SUSPENSION**

- Ball-action joint provides a full circumferential 45° swivel action
- Canopy bowl turn-locks onto bracket
- Baked white enamel (other finishes available as specified)

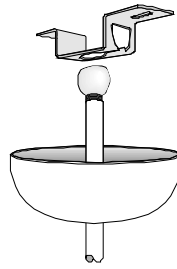

**565**

- Includes mounting bracket, turn-lock canopy bowl, and ball-action joint
- No power feed
- Minimum stem length 12"
- Maximum weight 50lbs per stem

**STEM (Specify Length)**

- 3/8" IPS, nominal OD 5/8"
- Threaded 1" each end
- 2 lock nuts provided per stem
- Standard lengths: 6", 12", 18", 24", 30", 36", 48"
- Baked white enamel finish

Other lengths & finishes are available as specified

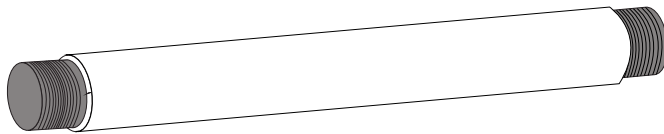

**Stem Length Calculation**

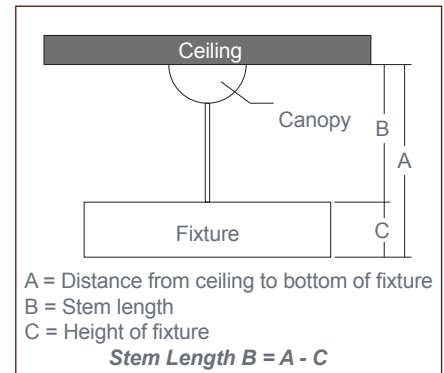

**Y-TOGGLE-END / CABLE SUSPENSION SYSTEM**

**YTCS10**

- Two (2) required per fixture
- **Self-locking device**
- Secures free end to ceiling

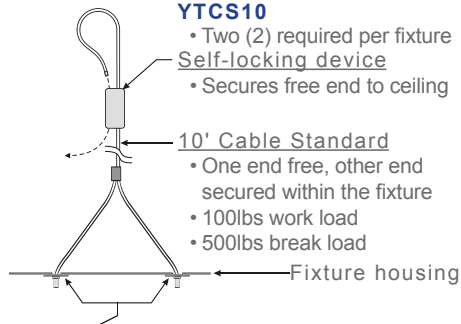

**10' Cable Standard**

- One end free, other end secured within the fixture
- 100lbs work load
- 500lbs break load

**Toggle Plates**

- Toggle plates through 3/8" passing holes and anchored in the fixture housing

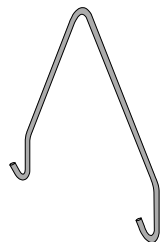

**V-HOOK**

- Hooks install at end of fixture and in chain mount coupling tabs between fixtures when chain mounted in rows
- Two (2) required per fixture

**CABLE SUSPENSION SYSTEM**

**CS10-Cable set without V-hook**

- Two (2) required per fixture

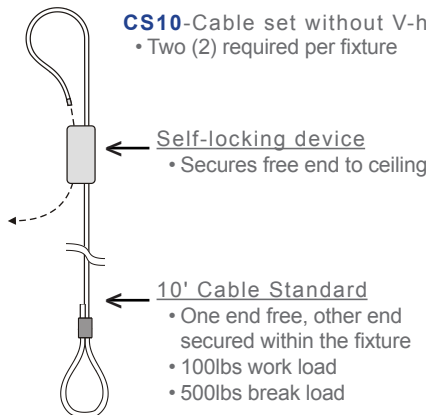

**Self-locking device**

- Secures free end to ceiling

**10' Cable Standard**

- One end free, other end secured within the fixture
- 100lbs work load
- 500lbs break load

**V-HOOK / CABLE SUSPENSION SYSTEM**

**V4CS10 - Cable set w/ V4-Hook**

**V6CS10 - Cable set w/ V6-Hook**

- Two (2) required per fixture

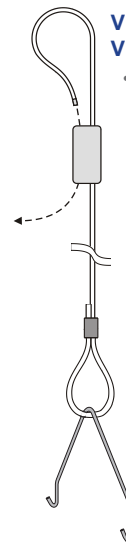

FOR FIXTURE SERIES	CAT. NO
4" LEG HEIGHT (110/200/240/500) Series	<b>V4</b>
6" LEG HEIGHT (300/400) Series	<b>V6</b>



**Los Angeles Lighting Mfg. Co.**

Contact Us  
 T: 626-454-8300  
 F: 626-454-8399  
 www.lalighting.com  
 10141 Olney Street  
 El Monte, CA 91731  
 Made in the USA



Due to continued product improvements and enhancements, Los Angeles Lighting Manufacturing Company reserves the right to alter specifications, dimensions, data, and/or materials without notice. Please visit our website to view the most current information.

© 2023 LOS ANGELES LIGHTING MANUFACTURING CO. ALL RIGHTS RESERVED.



### CHAIN MOUNT COUPLING

- Chain mount coupling with lift-up tabs for installation of V-Hooks when chain mounted
- Baked white enamel finish



LUMINAIRE MODEL	CAT. NO.
IND200, IND500, IND600, STR200, STR500	CMC-200
IND240, STR240	CMC-240
IND220, KD1200, KDS200, STR220	CMC-245
IND300, STR300	CMC-300
IND400, STR400	CMC-400
MXIND210, MXSTR210	CMC-MX210
INW105, INW110	CMC-INW1XX
STW100 (ONLY FOR 4FT & 8FT FIXTURES)	CMC-STW100
INW200, STW200	CMC-XXW200

### 45° MOUNTING BRACKET

#### 45MB

- 45° mounting bracket designed for mounting lighting fixtures at 45° angle
- Ideal for wall or ceiling mount applications
- 18 gauge electro-galvanized steel
- Baked white powder coated finish
- Two mounting brackets required for each 2' 4', or 8' luminaire

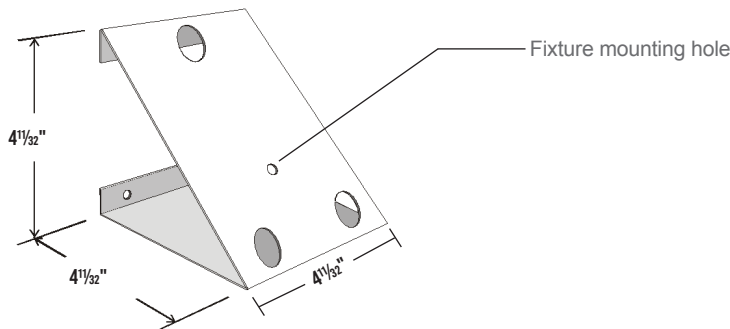

Note: Must drill own holes for 45° mounting bracket

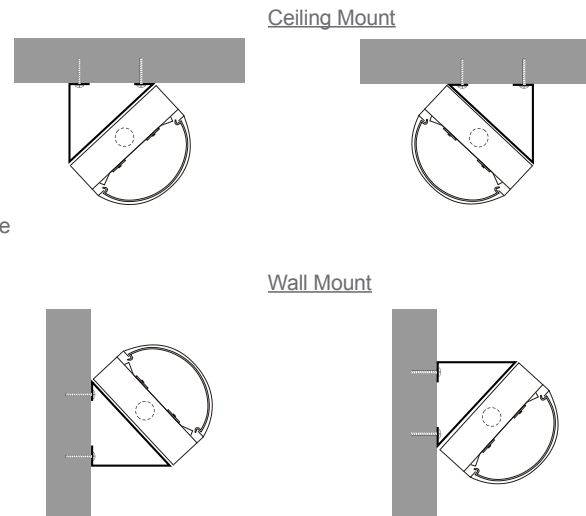

### CEILING SPACERS

- Minimum one (1) of each per fixture
- May need to drill own holes

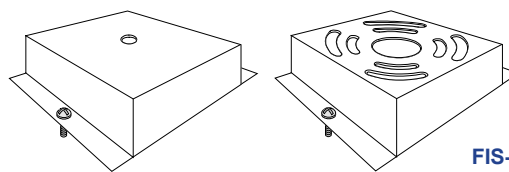

#### CS-3

- Closed spacer, spaces fixture 11/2" from ceiling when required by code

#### FIS-7

- Feed-in spacer mounts to junction box, spaces fixture 11/2" from ceiling

### CHANNEL HANGERS

- Spaces fixture 11/2" from ceiling while allowing easy installation along side groove
- Baked white enamel finish

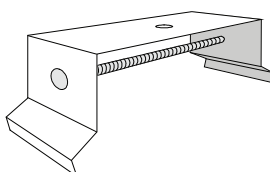

LUMINAIRE MODEL	CAT. NO.
IND200, IND500, IND600, STR200, STR500	CH-200
IND240, STR240	CH-240
IND300, STR300	CH-300
IND400, STR400	CH-400
HBI600, HBI609, HBS100, HBW100	CH-HB
IBT100, IBT200, IBT300	CH-IBT



**Los Angeles Lighting Mfg. Co.**

Contact Us  
 T: 626-454-8300  
 F: 626-454-8399  
 www.lalighting.com  
 10141 Olney Street  
 El Monte, CA 91731  
 Made in the USA



Due to continued product improvements and enhancements, Los Angeles Lighting Manufacturing Company reserves the right to alter specifications, dimensions, data, and/or materials without notice. Please visit our website to view the most current information.

© 2023 LOS ANGELES LIGHTING MANUFACTURING CO. ALL RIGHTS RESERVED.

