



# BAYLIGHTER™ LED

## HBI800 SERIES

INDUSTRIAL WET LOCATION HIGH BAY LUMINAIRE

DATE	
JOB	

WWW.LALIGHTING.COM  
626-454-8300

### SUSPENSION MOUNTED WET LOCATION HIGH BAY LED LUMINAIRE

### DIMENSIONS

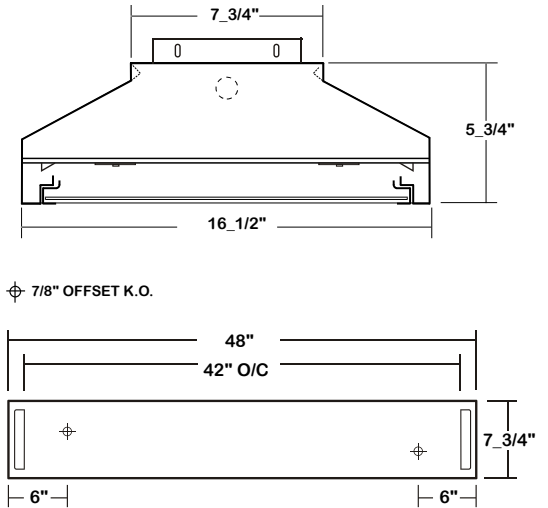

### APPLICATIONS

- Commercial, Industrial, Wet Location

### FEATURES

- Wet location (UL listed with sprinkler test)
- 0-10V dimming driver standard
- Supports California Title 24 compliance
- Safety cables attached to door frame and LED gear tray

### OPTIONS

- High (HT) ambient temperature version available for extreme temperature ranges
- Full customization available upon request
- Additional lumen packages and color temperatures available
- Controls and sensors available
- Custom colors available
- Variety of lenses available
- Emergency battery pack available
- 10 kV surge protector
- 11 ga. wire guard available
- Cable suspension systems available
- Stainless steel tamper proof screws available

### SPECIFICATIONS

#### CONSTRUCTION

- 22 ga. electro-galvanized steel welded housing
- 20 ga. electro-galvanized steel door frame secured by full length stainless steel piano hinge and 2 captive stainless steel screws
- Two way neoprene gasket door frame

#### FINISH

- Baked white powder coated finish / painted after fabrication / minimum reflectance 90

#### OPTICAL

- Clear prismatic acrylic lens (nominal 0.125) standard

#### ELECTRICAL

- High efficiency drivers coupled with long-life LED
- Service life tested at 50,000-198,000 hours (L70), up to 59,000 hours (L90)
- Universal voltage 120V through 277V (347V / 480V available)
- Power Factor (PF) ≥ 0.9
- Total Harmonic Distortion (THD) ≤ 20%

#### LISTING

- UL USA and Canada listed / suitable for wet locations / UL listed with sprinkler test

#### WARRANTY

- 5-Year limited warranty standard. 10-Year limited warranty also available



Los Angeles Lighting Mfg. Co.

Contact Us

T: 626-454-8300  
F: 626-454-8399  
www.lalighting.com

10141 Olney Street  
El Monte, CA 91731  
Made in the USA



Due to continued product improvements and enhancements, Los Angeles Lighting Manufacturing Company reserves the right to alter specifications, dimensions, data, and/or materials without notice. Please visit our website to view the most current information.

© 2025 LOS ANGELES LIGHTING MANUFACTURING CO. ALL RIGHTS RESERVED.

Revised: 10/1/2025



**ORDERING INFORMATION** EXAMPLE: HBI800-24-4L-PA2-BPL1.5-DRDM-UNV-2/850HT

SERIES	LED LUMEN PACKAGE	NOMINAL LENGTH	OPTICAL		MECHANICAL	ELECTRICAL	DRIVER	VOLTAGE	# OF LED ROW	CRI / CCT
<b>HBI800</b>		<b>4L</b>								
<b>HBI800</b> Industrial Wet Location High Bay LED Luminaire  (Normal Ambient Temperature Version)	<b>8</b> Nom. 8000 Lumens <b>12</b> Nom. 12000 Lumens <b>16</b> Nom. 16000 Lumens <b>24</b> Nom. 24000 Lumens  <b>*Additional Lumen Packages Available</b>	<b>4L</b> 4'	<b>PA2</b> Clear Prismatic Acrylic Nom. 0.125  <b>FFA</b> Frosted Flat Acrylic  <b>PA</b> Clear Prismatic Acrylic  <b>FPA2</b> Frosted Prismatic Acrylic Nom. 0.125	<b>PPC2</b> Clear Prismatic Polycarbonate Nom. 0.125  <b>DRP2</b> High Impact Clear Prismatic Acrylic Nom. 0.125  <b>DRP8</b> High Impact Clear Prismatic Acrylic Nom. 0.187	<b>DL</b> Suitable for Damp Locations (Select when Cord or Plug is Specified)  <b>TP</b> Stainless Steel Tamper Proof Screws (Hex with Post)  *Leave Blank if Not Specified	<b>BPL1.5</b> 1500lm Emergency Battery Pack  <b>SP10</b> 10 kV Surge Protector  <b>MSxx</b> Motion Sensor  <b>WLC(LED RU)</b> Wireless Control  *Leave Blank if Not Specified	<b>DRDM</b> 0-10V Dimming Driver	<b>UNV</b> 120V-277V	<b>2</b> Two LED Rows (Only 8000 / 12000 / 16000 lumens Systems)  <b>4</b> Four LED Rows (Only 24000 lumens System)	<b>830</b> 80+CRI / 3000K Color Temp.  <b>835</b> 80+CRI / 3500K Color Temp.  <b>840</b> 80+CRI / 4000K Color Temp.  <b>850</b> 80+CRI / 5000K Color Temp.  *Additional Color Temp. Available

SERIES	LED LUMEN PACKAGE	NOMINAL LENGTH	OPTICAL		MECHANICAL	ELECTRICAL	DRIVER	VOLTAGE	# OF LED ROW	CRI / CCT	AMBIENT TEMP.
<b>HBI800</b>		<b>4L</b>									<b>HT</b>
<b>HBI800</b> Industrial Wet Location High Bay LED Luminaire  (HT - High Ambient Temperature Version)	<b>8</b> Nom. 8000 Lumens <b>12</b> Nom. 12000 Lumens <b>16</b> Nom. 16000 Lumens <b>24</b> Nom. 24000 Lumens  <b>*Additional Lumen Packages Available</b>	<b>4L</b> 4'	<b>PA2</b> Clear Prismatic Acrylic Nom. 0.125  <b>FFA</b> Frosted Flat Acrylic  <b>PA</b> Clear Prismatic Acrylic  <b>FPA2</b> Frosted Prismatic Acrylic Nom. 0.125	<b>PPC2</b> Clear Prismatic Polycarbonate Nom. 0.125  <b>DRP2</b> High Impact Clear Prismatic Acrylic Nom. 0.125  <b>DRP8</b> High Impact Clear Prismatic Acrylic Nom. 0.187	<b>DL</b> Suitable for Damp Locations (Select when Cord or Plug is Specified)  <b>TP</b> Stainless Steel Tamper Proof Screws (Hex with Post)  *Leave Blank if Not Specified	<b>BPL1.5</b> 1500lm Emergency Battery Pack  <b>SP10</b> 10 kV Surge Protector  <b>MSxx</b> Motion Sensor  <b>WLC(LED RU)</b> Wireless Control  *Leave Blank if Not Specified	<b>DRDM</b> 0-10V Dimming Driver	<b>UNV</b> 120V-277V	<b>1</b> One LED Row (Only 8000 / 12000 / 16000 lumens Systems)  <b>2</b> Two LED Rows (Only 24000 lumens System)	<b>835</b> 80+CRI / 3500K Color Temp.  <b>840</b> 80+CRI / 4000K Color Temp.  <b>850</b> 80+CRI / 5000K Color Temp.  *Additional Color Temp. Available	<b>HT</b> High Ambient Temp.
<p>Standard options for HBI800 shown above. For additional options, including lumen packages, controls, lenses, switches, finishes, and more, visit <a href="http://www.lalighting.com/resources">www.lalighting.com/resources</a> or contact customer service.</p>											



**Los Angeles Lighting Mfg. Co.**  
 Contact Us  
 T: 626-454-8300  
 F: 626-454-8399  
[www.lalighting.com](http://www.lalighting.com)  
 10141 Olney Street  
 El Monte, CA 91731  
 Made in the USA



Due to continued product improvements and enhancements, Los Angeles Lighting Manufacturing Company reserves the right to alter specifications, dimensions, data, and/or materials without notice. Please visit our website to view the most current information.

© 2025 LOS ANGELES LIGHTING MANUFACTURING CO. ALL RIGHTS RESERVED.

Revised: 10/1/2025



**SYSTEM DATA**

THESE ARE THE MOST POPULAR LUMEN PACKAGES. PLEASE CONSULT FACTORY FOR ADDITIONAL SYSTEM DATA.

	LED LUMEN PACKAGE	CRI / CCT	AMBIENT TEMP.	OPTICAL	DELIVERED LUMENS	SYSTEM WATTS	LUMINAIRE EFFICACY	FLUORESCENT EQUIVALENT	IES FILES
4'	8000 lm	850	HT	PA2	7177 lm	51.8 W	138.4 lm/W	4-F32T8, 2-F54T5HO	*
			Normal		7026 lm	66.7 W	105.4 lm/W		*
	8000HE lm	850	Normal	PA2	7177 lm	51.8 W	138.4 lm/W	4-F32T8, 2-F54T5HO	*
	12000 lm	850	HT	PA2	10647 lm	79.3 W	134.3 lm/W	6-F32T8, 3-F54T5HO	*
			Normal		10043 lm	104.6 W	96.0 lm/W		*
	12000HE lm	850	Normal	PA2	10504 lm	79.3 W	132.5 lm/W	6-F32T8, 3-F54T5HO	*
	16000 lm	840	HT	PA2	14820.6 lm	98.3 W	150.7 lm/W	4-F54T5HO	<a href="#">LA-T3153</a>
				DRP8	14530 lm	98.3 W	147.8 lm/W		<a href="#">LA-T3155</a>
	16000 lm	850	HT	PA2	14167 lm	99.0 W	143.1 lm/W		<a href="#">LA-T3147</a>
					Normal	14015 lm	107.6 W		130.3 lm/W
	24000 lm	840	HT	PA2	21644.4 lm	152 W	142.4 lm/W	6-F54T5HO	*
				DRP8	21220 lm	152 W	139.6 lm/W		*
	24000 lm	850	HT	PA2	21016 lm	152.3 W	137.9 lm/W		<a href="#">LA-T3149</a>
					Normal	20087 lm	209.3 W		96.0 lm/W
24000HE lm	850	Normal	PA2	21008 lm	158.5 W	132.5 lm/W	6-F54T5HO	*	

**OPTICAL OPTIONS**

**STANDARD LENSES FOR HBI800**

<b>PA2</b>	Clear Prismatic Acrylic, Nom. 0.125 OA Thickness, Female Prisms 3/16 Square Base
<b>FFA</b>	Frosted Flat Acrylic, No Thickness Specifie
<b>PA</b>	Clear Prismatic Acrylic, No Thickness Specified, Female Prisms 3/16 Square Bas
<b>FPA2</b>	Frosted Prismatic Acrylic, Nom. 0.125 OA Thickness
<b>PPC2</b>	Clear Prismatic Polycarbonate, Nom. 0.125 OA Thickness, Female Prisms 3/16 Square Base
<b>DRP2</b>	High Impact Clear Prismatic Acrylic, Nom. 0.125 OA Thickness, Female Prisms 3/16 Square Base
<b>DRP8</b>	High Impact Clear Prismatic Acrylic, Nom. 0.187 OA Thickness, Female Prisms 3/16 Square Base



**Los Angeles Lighting Mfg. Co.**  
 Contact Us  
 T: 626-454-8300 10141 Olney Street  
 F: 626-454-8399 El Monte, CA 91731  
 www.lalighting.com Made in the USA



Due to continued product improvements and enhancements, Los Angeles Lighting Manufacturing Company reserves the right to alter specifications, dimensions, data, and/or materials without notice. Please visit our website to view the most current information.

© 2025 LOS ANGELES LIGHTING MANUFACTURING CO. ALL RIGHTS RESERVED.

Revised: 10/1/2025



**DOOR FRAME**

**FEATURES**

- Full Length Stainless Steel Piano hinge
- Two Stainless Steel Captive Screws
- Inner Frame Lens Retainer Rail

**CROSS SECTION**

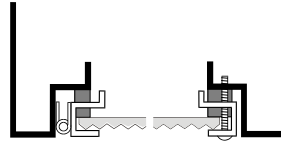

**ACCESSORIES**

**WG11-HBI800**

- 11 ga. Wire Guard
- Chrome epoxy powder coated finish

**Cable Suspension System**

- See [Mechanical Options](#) for additional Cable Suspension Systems

**YTCS10**

- Y-Toggle-End / Cable Suspension System

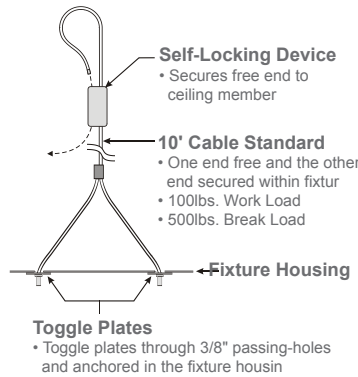

**V6CS10**

- V-Hook / Cable Suspension System
- Cable set with V6 hooks

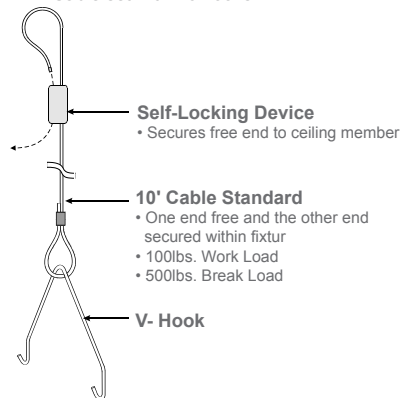

**CUSTOM COLORS**

**BLK - Matte Black**

**CS - Camaro Silver**

**BZ - Statuary Bronze**

Variety of [RAL colors](#) & [Axalta/DuPont colors](#) available upon request.



**Los Angeles Lighting Mfg. Co.**

Contact Us  
T: 626-454-8300  
F: 626-454-8399  
www.lalighting.com

10141 Olney Street  
El Monte, CA 91731  
Made in the USA



Due to continued product improvements and enhancements, Los Angeles Lighting Manufacturing Company reserves the right to alter specifications, dimensions, data, and/or materials without notice. Please visit our website to view the most current information.

© 2025 LOS ANGELES LIGHTING MANUFACTURING CO. ALL RIGHTS RESERVED.

Revised: 10/1/2025



**PHOTOMETRIC DATA - HBI800 SERIES**

**HBI800-16-4L-PA2-DRDM-UNV-2/850HT**

TEST NO.=LA-T3147  
 LED TYPE=144 LED MODULE  
 NO. OF MODULE=4  
 SYSTEM WATT (W)=99.0  
 CRI ≥ 80  
 L70(Hrs.) ≥ 50,000  
 PHOTOMETRY TYPE=C

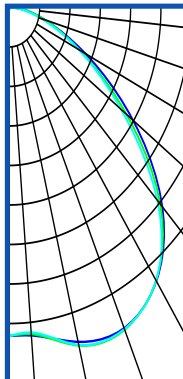
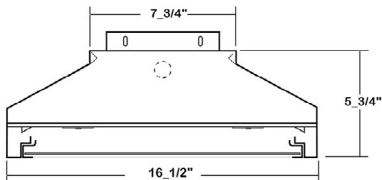

**CANDLEPOWER**

ANGLE	END	45	CROSS
0	7172	7172	7172
5	7031	7084	7118
15	7049	7059	7084
25	6674	6639	6602
35	5564	5449	5340
45	3620	3408	3188
55	1714	1587	1496
65	649	616	658
75	196	271	240
85	44	36	29
90	2	1	1
95	0	0	0
115	0	0	0
125	0	0	0
135	0	0	0
145	0	0	0
155	0	0	0
165	0	0	0
175	0	0	0
180	0	0	0

**ZONAL LUMEN SUMMARY**

DEGREES	LUMENS	% LAMP	% FIXTURE
0-30	5751	32.8	40.6
0-40	9175	52.4	64.7
0-60	13246	75.6	93.5
0-90	14167	80.9	100.0
90-120	.35	0.0	0.0
90-150	.35	0.0	0.0
90-180	.35	0.0	0.0
0-180	14167	80.9	100.00

Luminaire Output= 14167 lumens  
 Luminaire Efficacy = 143.1 lm/W

**SPACING CRITERION**

ALONG	ACROSS
1.25	1.21

**HBI800-24-4L-PA2-DRDM-UNV-2/850HT**

TEST NO.=LA-T3149  
 LED TYPE=144 LED MODULE  
 NO. OF MODULE=4  
 SYSTEM WATT (W)=152.3  
 CRI ≥ 80  
 L70(Hrs.) ≥ 50,000  
 PHOTOMETRY TYPE=C

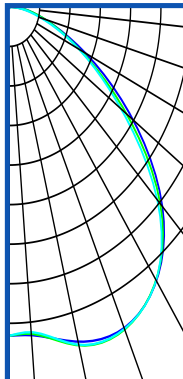
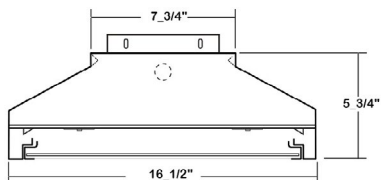

**CANDLEPOWER**

ANGLE	END	45	CROSS
0	10497	10497	10497
5	10581	10449	10609
15	10423	10419	10511
25	9897	9859	9777
35	8273	8091	7885
45	5386	5064	4776
55	2560	2345	2207
65	954	912	984
75	291	403	359
85	67	53	41
90	2	2	2
95	0	0	0
115	0	0	0
125	0	0	0
135	0	0	0
145	0	0	0
155	0	0	0
165	0	0	0
175	0	0	0
180	0	0	0

**ZONAL LUMEN SUMMARY**

DEGREES	LUMENS	% LAMP	% FIXTURE
0-30	8523	32.8	40.5
0-40	13602	52.4	64.7
0-60	19652	75.6	93.5
0-90	21016	80.9	100.0
90-120	.48	0.0	0.0
90-150	.48	0.0	0.0
90-180	.48	0.0	0.0
0-180	21016	80.9	100.00

Luminaire Output= 21016 lumens  
 Luminaire Efficacy = 137.9 lm/W

**SPACING CRITERION**

ALONG	ACROSS
1.26	1.23



**LOS ANGELES LIGHTING MFG. CO.**

10141 OLNEY ST. / EL MONTE, CA 91731  
 TEL 626-454-8300 | FAX 626-454-8399

[www.lalighting.com](http://www.lalighting.com)